

WM-PT Series

Use & Care Manual

1. INTRODUCTION

This manual contains specifications along with installation and operating instructions for your digital paddle wheel flow meter. Please read this manual carefully. It will answer your questions and allow you to get the most from this meter.

2. DESCRIPTION

This digital meter is a paddle wheel type, microprocessor-based instrument. The compact, efficient design operates with negligible head loss. The meter is waterproof and battery powered. This allows it to be installed outdoors where no external power is available. Calibration of the meter is accomplished by selecting the pipe size and schedule then choosing the units. A correction factor can also be calculated and entered to account for special operating conditions.

3. THEORY OF OPERATION

When the flow meter is properly installed, the paddle spins at a rate linearly proportional to the velocity of the flow. A magnet, contained within the paddle, actuates a switch every time the paddle revolves. By measuring the time it takes the paddle to revolve, the velocity is determined, and, from this, the flow rate is calculated. A stable reading is obtained by averaging many revolutions of the paddle.



4. SPECIFICATIONS

Operating pressure/temperature corresponds to standard schedule 40 & 80 PVC pipe with **maximum pressure not to exceed 150 PSI.**

Wetted Materials:

PVC, Stainless Steel Paddle Pin
Buna N or Viton O-Ring

Ambient Operating Temperature:

20° to 130° F

Maximum % Solids:

1% of Fluid Volume

Accuracy:

±1.5% Full Scale

Linearity:

±1.5%

Repeatability:

±1%

5. GENERAL INSTALLATION GUIDELINES (All types)

Flow meters will only produce accurate results under the following conditions:

- the pipe is full
- the flow rate is within the recommended range
- the meter is properly installed

In order for the meter to perform accurately, there must be a certain length of straight and level pipe both upstream and downstream from the meter. This is needed to stabilize the flow and eliminate turbulence in the media at the point of installation. The upstream length required is longer than the downstream, and both requirements are directly proportional to the diameter of the pipe. Use the guidelines below to choose the location of your meter.

In testing this and other paddle wheel flow meters, it was found that accurate readings were only obtainable when the meter was installed in a section of pipe that was truly straight; no sagging or drooping. With the flow meter mounted in a sagging pipe, results were affected by as much as 5%. Use the diagram below as a guideline for required straight run before and after the meter. If the required lengths cannot be met, the meter will still work, however accuracy will be compromised. Luckily, the inaccuracy is linear throughout the flow range and the "percent adjustment" factor can be calculated and modified as outlined in the Calibration section of this manual.

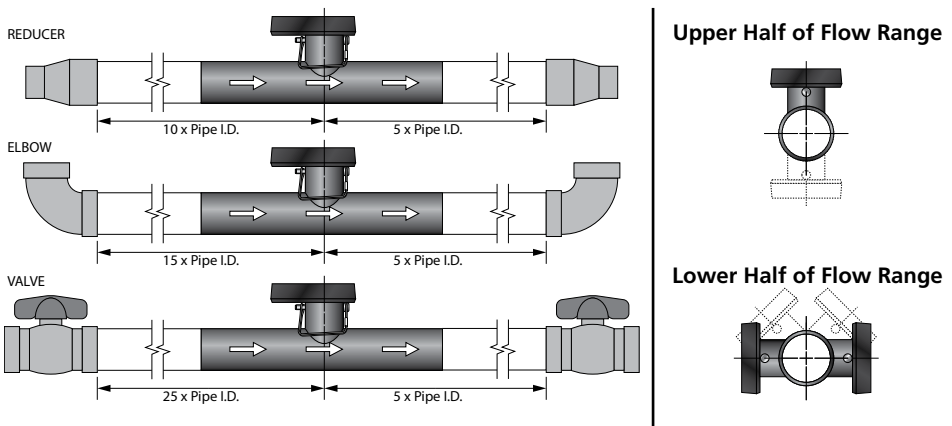

Vertical Installations:

If possible, mount the flow meter in a pipe with an upward flow. Upward flows will assure that the pipe remains full of liquid; however, downward flows can be measured if the pipe is slightly pressurized to assure that the pipe remains full.

Horizontal Installations:

If the flow to be measured is typically in the upper half of the recommended flow rate range (see chart in Section 12), the meter should be mounted on either the top (12 o'clock) or bottom (6 o'clock) of the pipe. If the flow meter will be operated in the lower half of the flow rate range, the meter should be mounted on the pipe as shown in the diagram above. If the flow rate is low and the meter is mounted on the top of the pipe, air bubbles may become entrapped around the paddle and produce inaccurate results. Likewise, mounting the flow meter on the bottom of the pipe may entrap sediment that will eventually effect the operation of the paddle wheel. However, if no suspended particles are present, a bottom-mounted position is acceptable with low flows. The life of the paddle wheel will be extended if the meter is mounted on either the top or bottom of the pipe.

6. INSTALLATION (Pipe Mounted Meters)

After determining a suitable location, a section of pipe will need to be removed from the existing system equal to the length of the supplied section of pipe plus the length added by the coupling fittings. Be sure the mounting location and position will allow the flow meter to be removed for cleaning/servicing. Install using traditional PVC plumbing procedures.

Align the holes for the stainless steel pin, then using a gentle rocking motion, press the meter into the adapter, and install the pin.

7. INSTALLATION (Insertion Flow Meters on Existing Pipes)

Be sure the mounting location and position will allow the meter to be removed and cleaned.

1. Referring to the image below, install the hose clamps on the pipe.
2. Mount the adapter to the pipe following the steps below for the type of pipe.

PVC Pipes

Prime the mating surfaces of the adapter and pipe with PVC primer.

Apply PVC cement to the pipe and the adapter.

Mount the adapter to the pipe.

Slide the clamps into the adapter grooves and tighten them enough to pull the adapter tight to the pipe.

Wipe off any excess cement.

Let it dry for 20 min. (refer to the cement manufacturer's instructions)

Pipes of Other Materials

Using medium grit sandpaper, clean the pipe.

Clean the curved part of the adapter and the pipe using an acetone soaked rag.

Apply a layer of RTV silicon sealer to the pipe and adapter.

Mount the adapter to the pipe.

Slide the clamps into the adapter grooves and tighten, this pulls the adapter tight to the pipe.

Let the assembly cure for 2 hours. (refer to the sealer manufacturer's instructions)

3. Using a 1 1/2" hole saw and the adapter as a guide, bore a hole through the pipe. De burr and clean up the shavings.
4. Align the holes for the retaining pin, then using a gentle rocking motion, press the meter into the adapter, and install the pin.



8. READING THE DISPLAY

The left side of the flow rate display (upper most display window) contains two icons resembling paddle wheels. These icons will appear and alternately flash when the paddle wheel is rotating. If the flow rate is too low and/or the paddle is stuck, the paddle icons will disappear. In this case the flow rate will have to be increased, the pipe diameter reduced or the paddle wheel freed. The resettable totalizer can be reset using the middle "Reset" button, whereas the totalizer is not resettable. Pressing the "Size" button will display the currently programmed size and schedule of the pipe followed by the units and finally the percent adjust factor will be displayed. Refer to the calibration section if any of the information is incorrect.

To be able to store totalized data for longer periods, the larger sized meters will have the totalizer registers stored with a multiplier. The multiplier, either x10 or x100, will be displayed every 6 seconds. Example, a 4" meter will have the totalizer registering in gallons x 10. Every 6 seconds "by 10" will be displayed. To get the correct readings both totalizers must be multiplied by 10. The 6" and 8" meters use a x100 multiplier for the liter units.

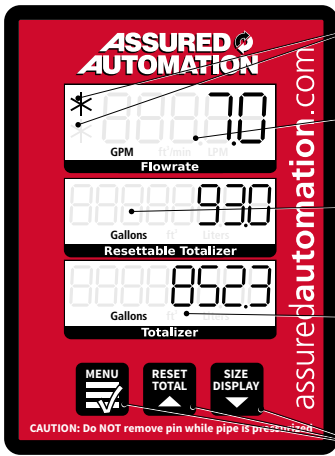

Flow Indicating Icons

- Flash alternately when there is flow
- BOTH remain off when flow stops

Flowrate

- Displays current rate of flow.
- Rate is shown in unit of measure displayed

Resettable Totalizer

- Displays total flow since last reset (batch total)
- Volume shown in unit of measure displayed
- RESET using the RESET TOTAL button below

Totalizer











- Displays total flow of ALL-TIME
- Volume shown in unit of measure displayed
- NOT RESETTABLE!
(will reset on battery replacement at factory)

3-button Keypad

- MENU: press and hold to enter programming mode
- RESET TOTAL: press to reset the Resettable Totalizer (batch total)
- SIZE DISPLAY: press to view current settings

9. PROGRAMMING AND SETUP PROCEDURE

To program the unit for your application, follow these steps using the 3-button keypad.

1. Press and hold the  button until you see the word **PRESETS** appear (approx 5 sec.)
2. Press the  &  buttons to scroll through the list of standard pipe sizes and schedules. When the desired pipe is displayed, press the  button to accept that value and proceed to the **Units**
3. When **Units** appears, use the  &  buttons to cycle through the 3 choices of Gallons or Liters. When the desired unit of measure is displayed, press the accept that  button to value and proceed to the **PERCENT ADJUST**
4. When **PERCENT ADJUST** appears, use the  &  buttons to set the correct percentage (see calibration examples on pages 5 & 6). When the desired percentage is displayed, press the  button to accept that value and proceed to the normal operating mode.

10. CALIBRATION

The meter can be calibrated to greatly reduce any inaccuracies caused by various conditions in any particular application including installation location, mounting position, and fluid viscosity.

Calculating the "Percent Adjust" Factor:

1. Place a tank of known volume at the outlet.
2. Using a stopwatch, determine the time it takes to fill the tank.
3. Divide the volume of water (in gallons) by the time (in minutes), this will result in the actual flow rate.
4. Divide the actual flow rate by the current reading, this will result in a multiplier.
5. Next, using the procedure outlined in on page 4, access and set the "percent adjust" factor.

The following examples demonstrate the procedure for calculating the proper value to use.

Example 1:

A 1" meter is mounted in a location that does not allow the recommended straight run of pipe. This common problem usually affects the accuracy of the meter but not the linearity or repeatability. By recalibrating the meter it is possible to reduce this error.

Facts:

- The meter is indicating a flow rate of 33.4 gpm.
- The flow is diverted into a 100 gallon tank that takes 175 seconds to fill.

The ACTUAL flow rate is calculated to be 34.3 gpm as follows:

$$\text{actual flow rate (in gpm)} = \frac{\text{volume of tank in gallons}}{\text{(seconds to fill / 60)}}$$

$$\frac{100 \text{ gallons}}{(175 \text{ sec} / 60 \text{ sec/min})} = 2.917 \text{ min}$$

$$100 \text{ gallons} / 2.917 \text{ min} = 34.3 \text{ gpm}$$

The Percent Adjust Factor is calculated to be 102.7 as follows:

$$\text{Percent Adjust Factor} = \frac{\text{actual flow rate (in gpm)}}{\text{metered flow rate (in gpm)}} \times 100$$

10. CALIBRATION *(continued)*

Example 2:

Calibrating for a pipe size that is not listed in the factory presets

Facts:

- 1.96" is the inner diameter of the pipe being used.
- 1.94" is the closest factory preset available to select (2" sched 80)
- The cross-sectional area of the pipe increases as a SQUARE of the diameter

$$\text{Percent Adjust Factor} = \frac{\text{unlisted pipe I.D.}^2}{\text{closest pipe I.D.}^2} \times 100$$

$$\text{Percent Adjust Factor} = \frac{1.96 \text{ inches}^2}{1.94 \text{ inches}^2} \times 100$$

$$\text{Percent Adjust Factor} = \frac{3.8416}{3.7636} \times 100$$

$$\text{Percent Adjust Factor} = 1.021 \times 100 = 102.1$$

11. CARE AND MAINTENANCE

The meter should operate maintenance free as long as it is installed properly, used within the recommended flow range, and the fluid being metered is clean and free of debris. If the meter stops detecting flow, the output becomes erratic or seems lower than expected, the paddle wheel should be inspected, and cleaned if necessary.

Although this meter design is very debris tolerant, debris is still the most common cause of problems. The paddle wheel should always spin freely. If it does not, first inspect the paddle wheel and pin looking for any damage or debris lodged between the paddle wheel and housing. If any damage is found, the paddle wheel and pin should be replaced. If nothing is found, it is possible that there is fine particulate that has gotten between the paddle wheel and pin. Removing the paddle wheel is the next step.

Removing the Paddle Wheel and Pin:

To remove the pin, use a 1/16" drill bit clamped in a vice or locking pliers to push the pin through the meter until enough of the pin is exposed to pull it out from the other side using pliers. **ONLY USE PLIERS ON THE ENDS OF THE PIN!** The portion of the pin that ends up exposed in the middle and the paddle wheel surrounds cannot be scratched or marred. Any scratches or deformation to that part of the pin will affect the performance of the meter.

Other Possible Causes of Poor Performance	Solution
Inadequate lengths of pipe before or after meter	Install properly
Sagging or sloping pipe	Correct pipe to straight and level
Bubbles or silt trapped around the paddle	Clean paddle and purge air
Pipe not full of water	Purge air and eliminate entry of air
Flow rate too low	Reduce the pipe size

Replacing the Batteries:

The battery is sealed inside the enclosure, thereby reducing the likelihood of water leakage. Advancements in battery powered semiconductors have made a battery life of 5+ years possible. When the display becomes faint the meter will have to be sent in and a new battery installed. When the battery is replaced, the meter will be reset to factory settings. you will need to re-program your settings, and the Totalizer data will be lost.



Note: Plugs are available to replace the meter during service, so that the line on which the meter is installed can still be used.

12. FLOW RANGES

Pipe Size	PVC Schedule	Inner Diameter (in inches)	Flow Range			
			GPM	LPM	ft ³	
1/2"	80	0.55	0.6 - 15	2.27 - 56.78	0.08 - 2.01	ONLY Available in Pipe Mount
3/4"	80	0.74	1.5 - 30	5.68 - 113.56	0.20 - 4.01	
1"	80	0.96	5 - 55	18.93 - 208.20	0.668 - 7.35	
1 1/2"	40	1.61	10 - 125	37.85 - 473.18	1.337 - 16.71	Available in Pipe Mount OR Insertion Mount
	80	1.50				
2"	40	2.07	15 - 200	56.78 - 757.08	2.005 - 26.74	
	80	1.94				
3"	40	3.07	40 - 450	151.42 - 1703.44	5.35 - 60.16	
	80	2.90				
4"	40	4.03	60 - 800	227.12 - 3028.33	8.02 - 106.94	
	80	3.83				
6"	40	6.07	120 - 1800	454.25 - 6813.74	16.04 - 240.63	
	80	5.76				
8"	40	7.98	250 - 3200	946.35 - 12113.32	33.42 - 427.78	ONLY Available in Insertion Mount
	80	7.63				